

Magnetic Bearings and Bearingless Motors



Wolfgang Gruber, wolfgang.gruber@jku.at



Institute for Electrical Drives and Power Electronics (Head: Univ. Prof. Dipl. Ing. Dr. Gerd Bramerdorfer)



Research Areas:

Fractional Horsepower Drives and Actuators

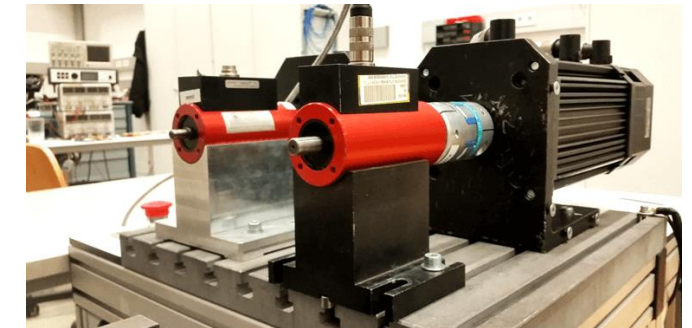

Magnetic Bearing Technology

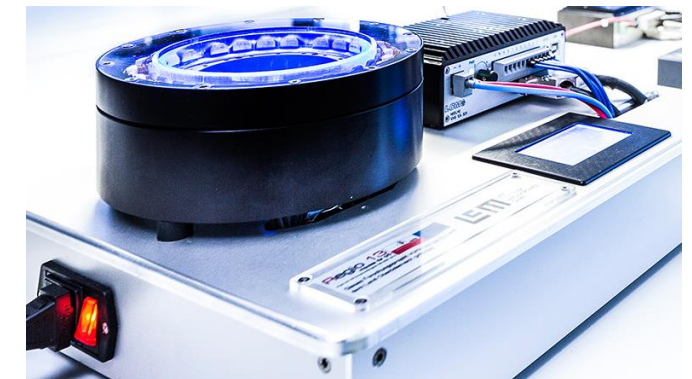
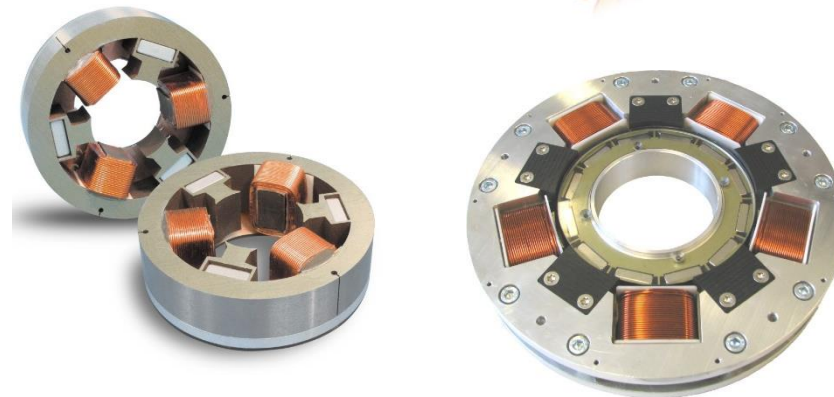

Lecturer: Univ. Prof. Dipl. Ing. Dr. Wolfgang Gruber

Table of Content

Part 1: Basic Principles for Magnetic Levitation

Part 2: Active Magnetic Bearings Basics Axial and Radial Bearings

Part 3: Bearingless (Slice) Motors Definition Topologies Application Example

Part 4: Bearingless Motor Model Force and Torque Generation Force-Current Matrix

Part 5: Bearingless Motor Control Control Scheme Application Examples

Part 6: Recent Research Projects Bearingless Fan Magnetically Levitated Yarn Spinning System

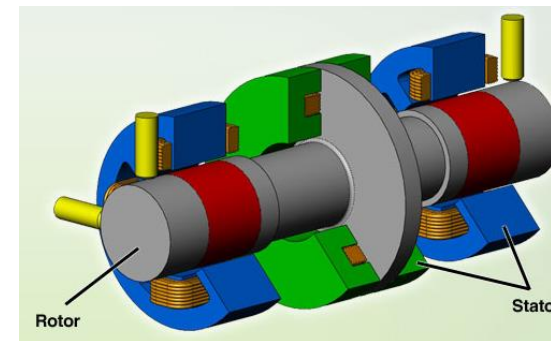
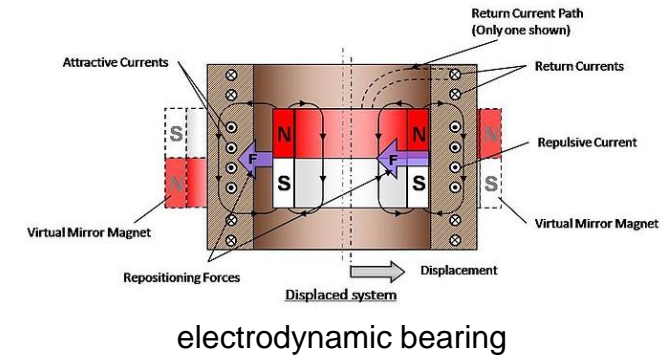
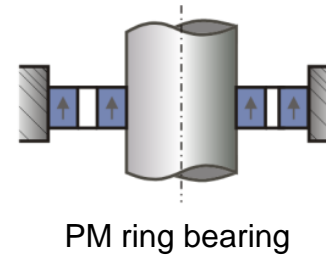

magnetically levitated shaft

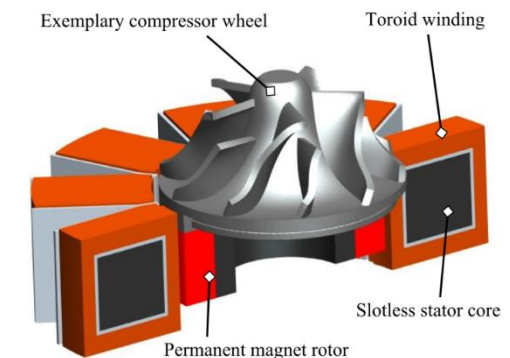
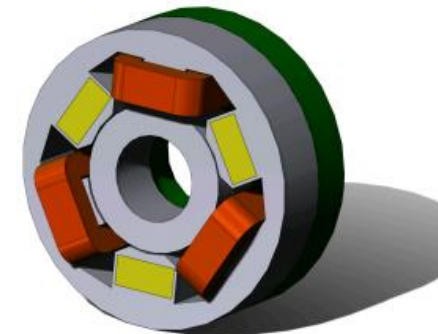

bearingless high-speed motor