



TERMOMEHANIKA -O KOLEGIJU-

MARKO ČANADIJA

Tehnički fakultet Sveučilišta u Rijeci

SADRŽAJ

Predavanja:

- Teorija – štapovi, grede, ploče
- Osnove MKE u termomehanici
- Cjevovodi
- Mehaničko ponašanje materijala na povišenim temperaturama

Vježbe:

- MKE - Femap

OBVEZE

- Napisati dvije domaće zadaće
- Izraditi seminarski rad tematike po vlastitom izboru ili po prijedlogu nositelja kolegija
- Završni ispit: pismeni

SEMINARI

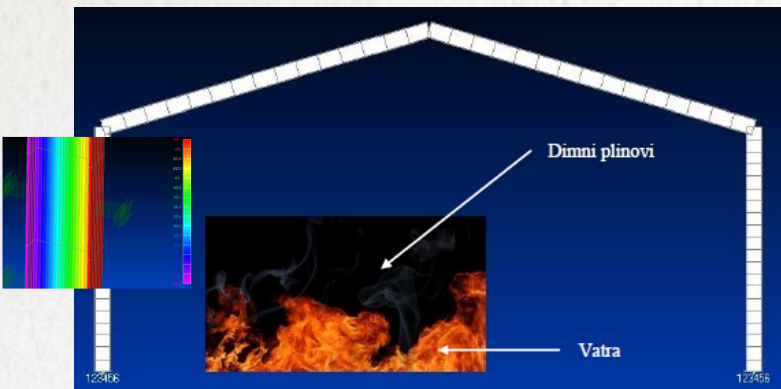

Mihael Zamuda, 2012/13

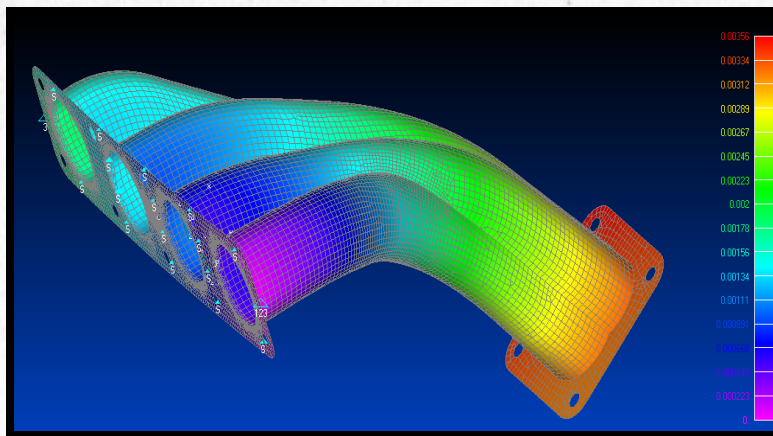

Igor Felc, 2012/13

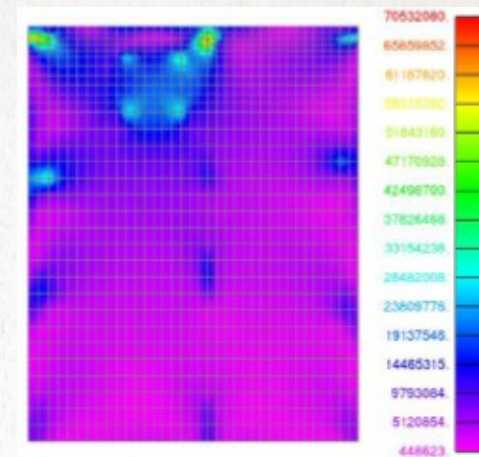

Sebastijan Blažević, 2013/14

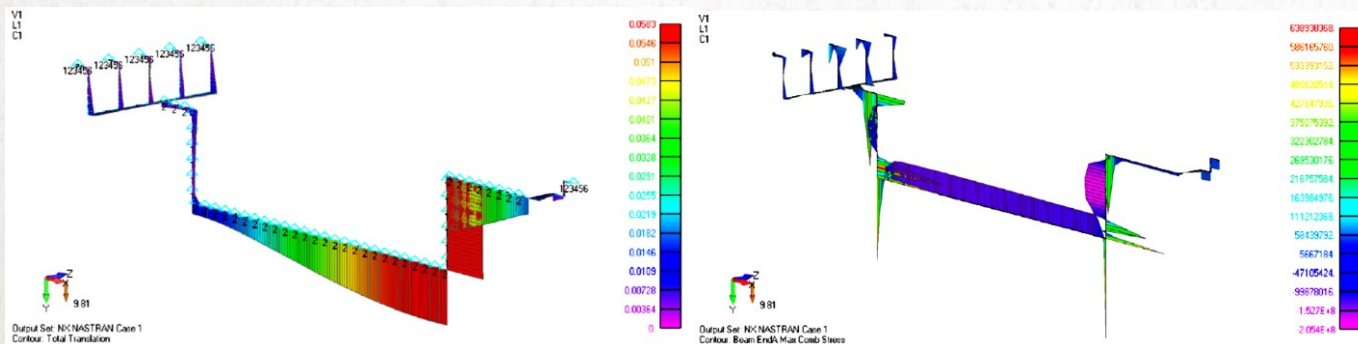

Ivan Gligora, 2010/11

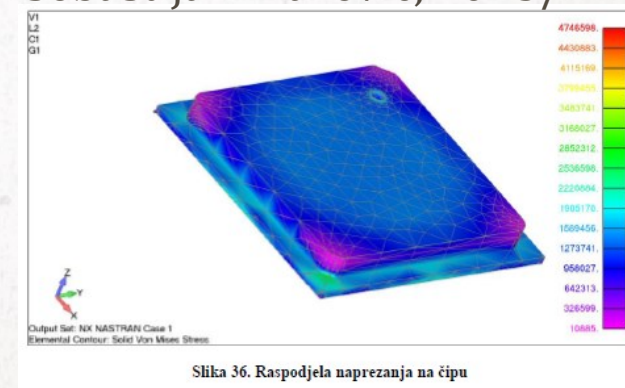

Slika 36. Raspodjela naprezanja na čipu

SEMINARI

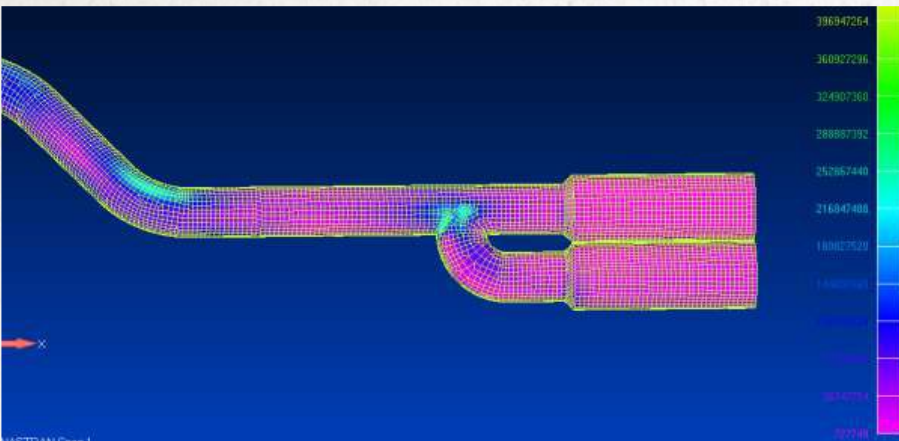

Fran Ledić, 2015/16

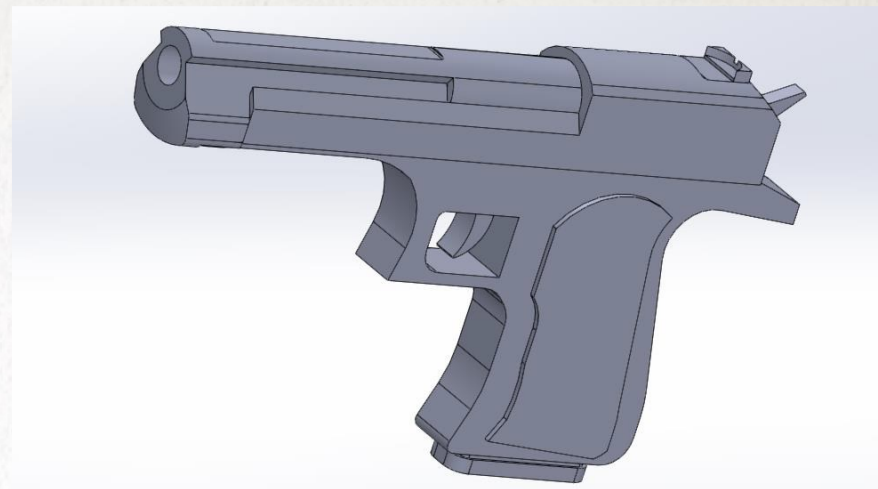

Filip Nikolić, 2015/16

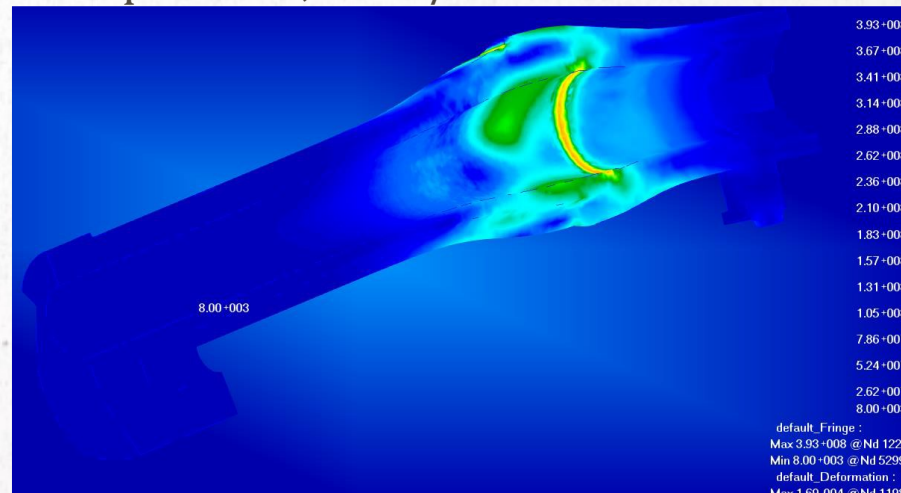

SEMINARI

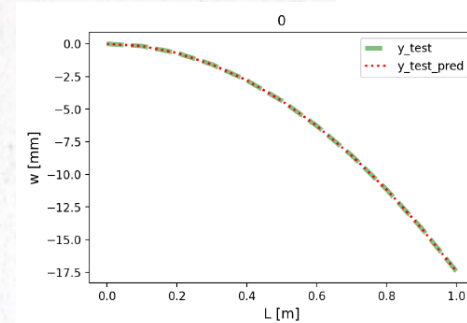

Slika 8.1 usporedba proračuna i predviđanja

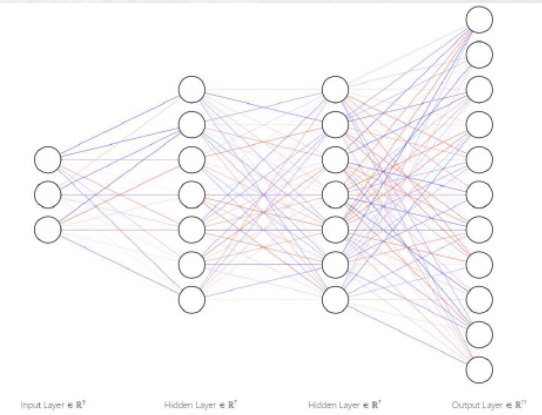

Slika 7.1 neuronska mreža

Treniranje modela:

```
# Prekid treniranja nakon n broja jednakih ciklusa (patience=n)
earlystopper = EarlyStopping(monitor='val_loss',
                             min_delta=0,
                             patience=20,
                             verbose=1,
                             mode='auto')

# Treniranje modela
history = model.fit(X_train, y_train,
                   epochs = 5000,
                   validation_split = 0.3,
                   shuffle = True,
                   verbose = 1,
                   batch_size=32,
                   callbacks = [earlystopper])

history_dict=history.history

loss_values = history_dict['loss'] # Ocjena poklapanja model s podacima
za treniranje
val_loss_values=history_dict['val_loss'] # Ocjena poklapanja modela s
validacijskim podacima
```

Marino Odorčić, 2022/23

Prof. dr. sc. Marko Čanadija

DIPLOMSKI RADOVI

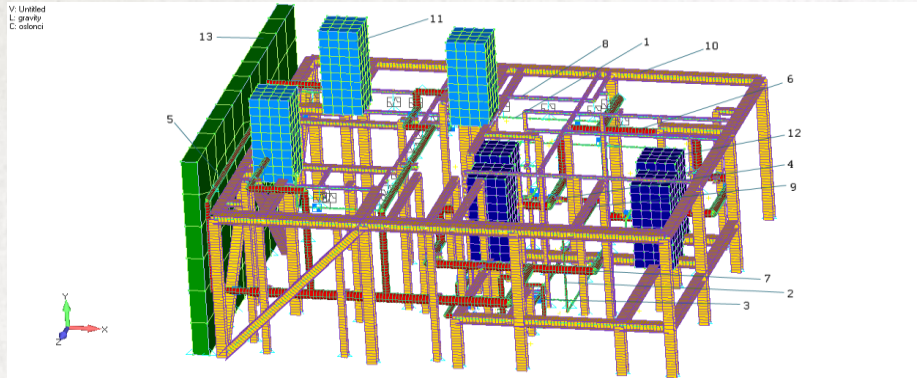

Boris Plišić, 2010

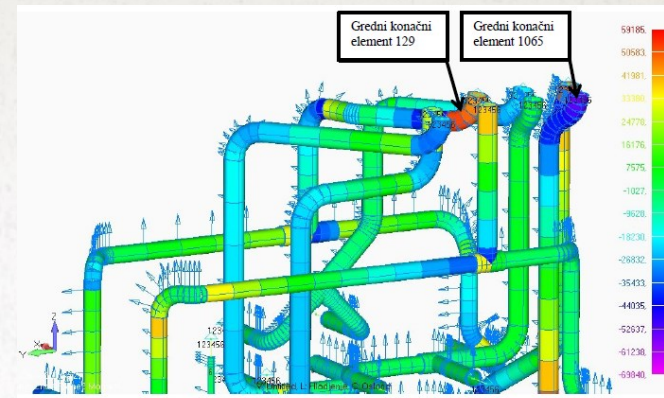

Slika 99. Kritično koljeno – gredni konačni element 1065 i 129

Franko Hrvatin, 2014

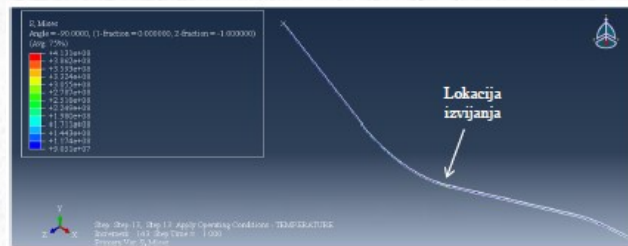

Josip Marić
2015

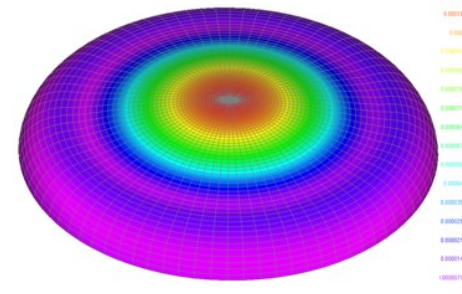
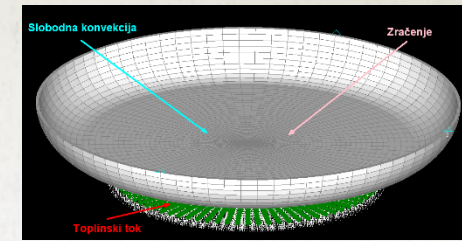

Slika 4.16. Prikaz deformacije kuhinjske tave (donja strana) nakon deset ciklusa grijanje-hlađenje.

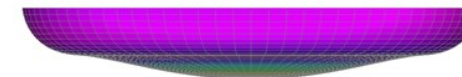

Slika 4.17. Prikaz deformacije kuhinjske tave (vodoravni položaj) nakon deset ciklusa grijanje-hlađenje.

Milenko Jokić, 2007

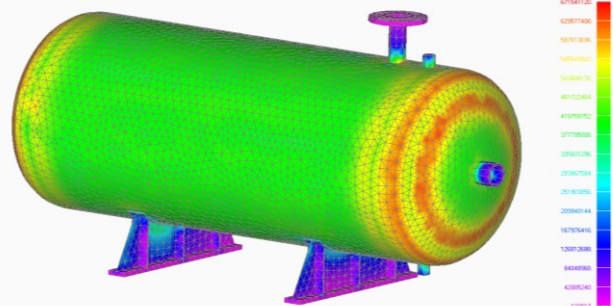

Livio Linić, 2011

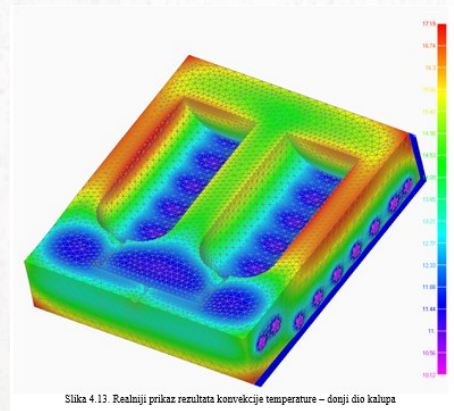

Marko Matić, 2008

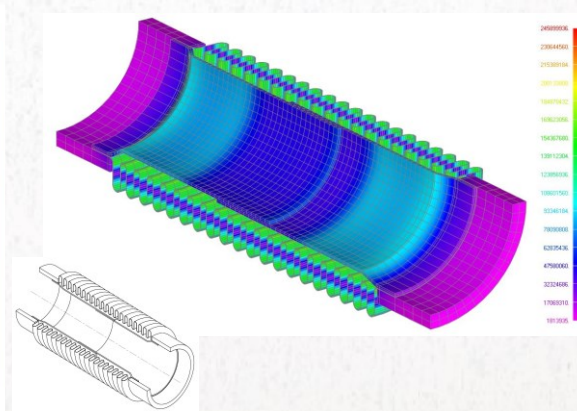

Stefan Šegulja, 2010

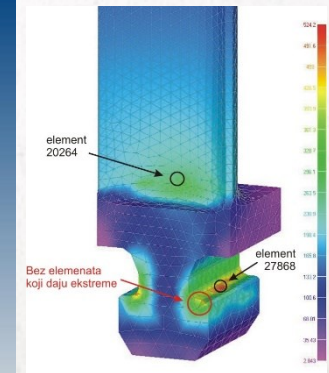
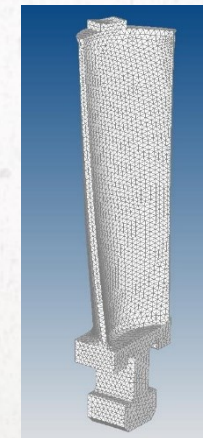

Davor Vozila, 2008

DIPLOMSKI RADOVI

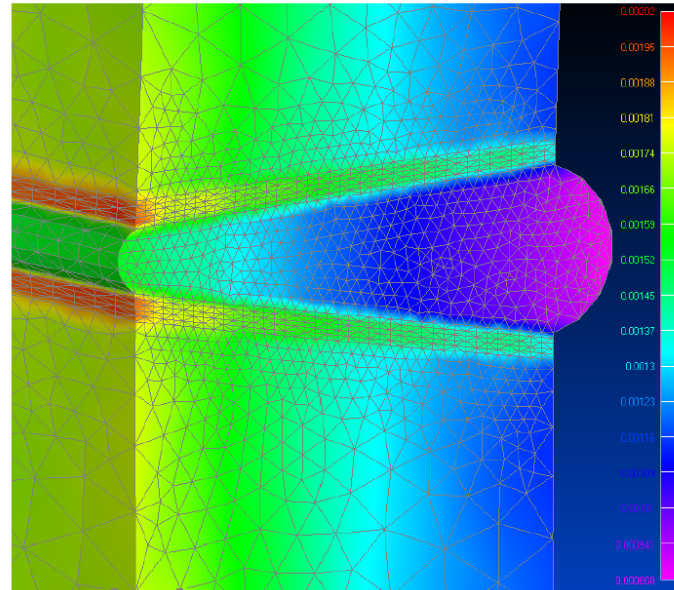
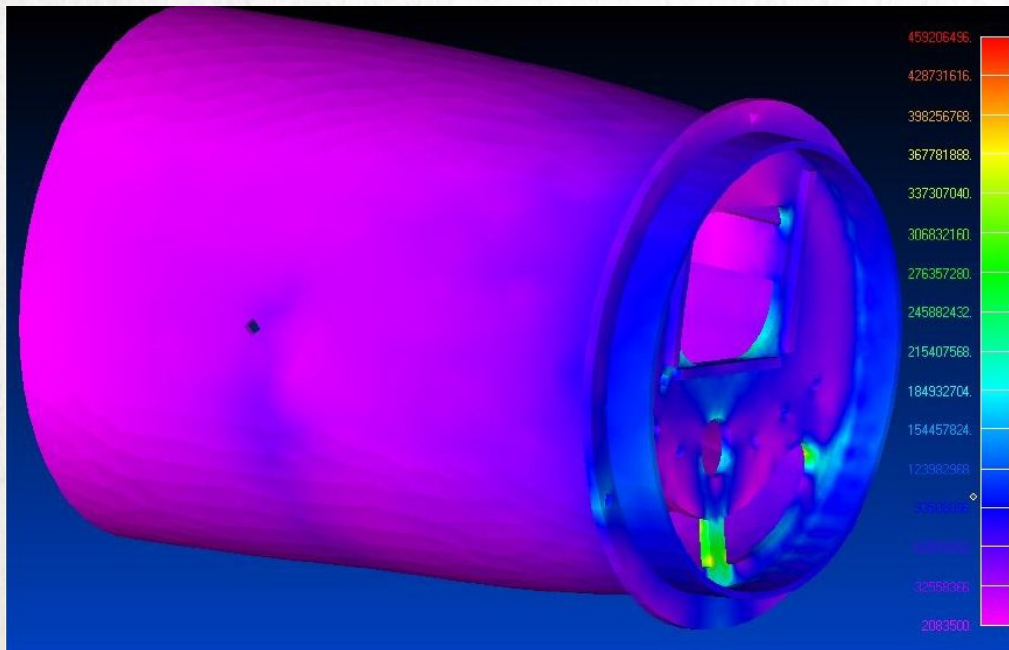

Sl. 29: Deformacija zbog puzanja (Solid Creep Strain) na manjem zavaru (600°C)

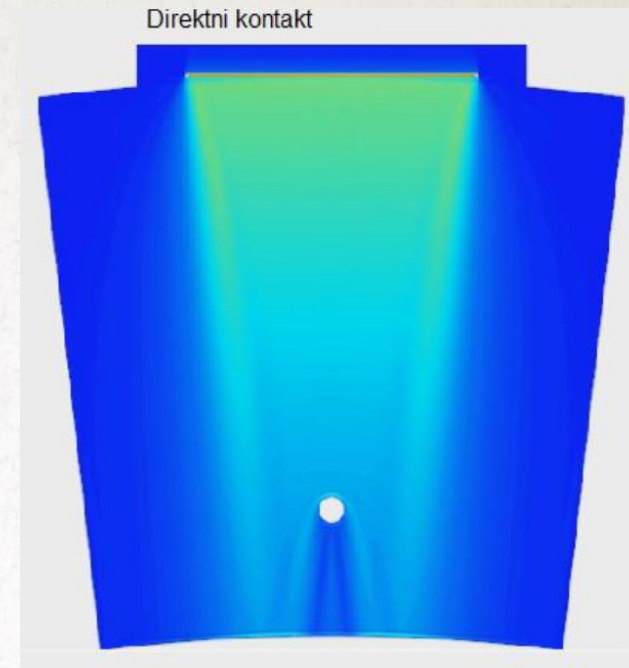

Nikola Bunčić, 2018

Igor Knežević, 2016

DIPLOMSKI RADOVI

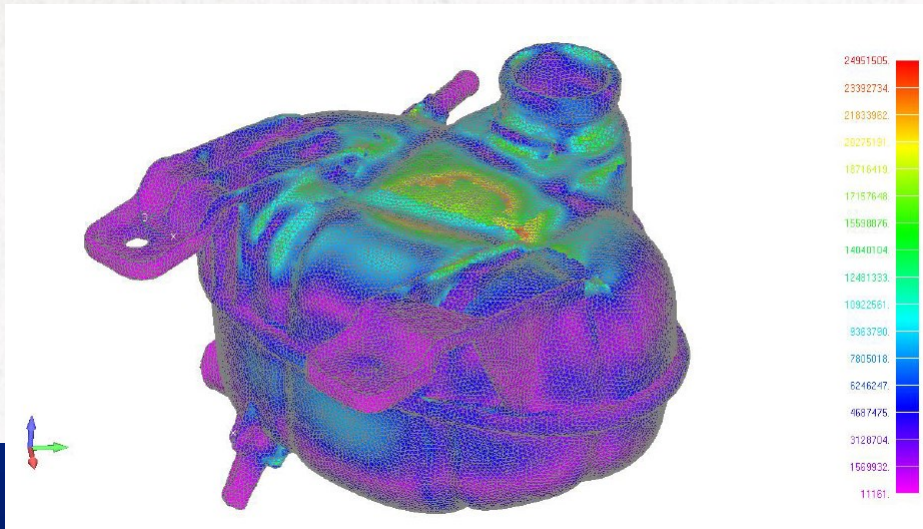

Daniel Morožin, 2020

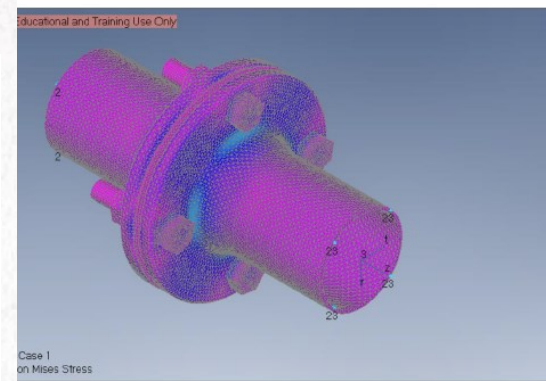

Slika 8.22: Naprezanja zagrijanog prirubničkog spoja

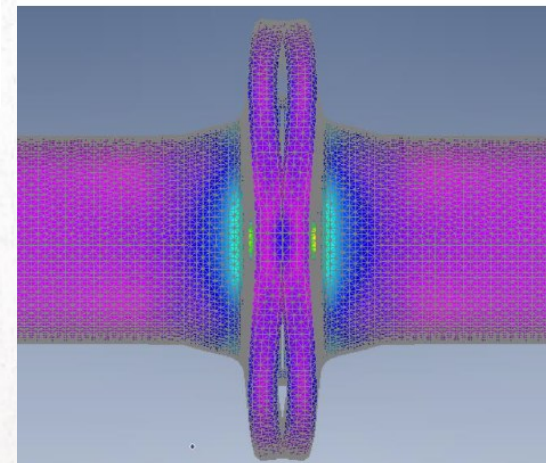

Slika 8.23: Prikaz deformacija prirubnice

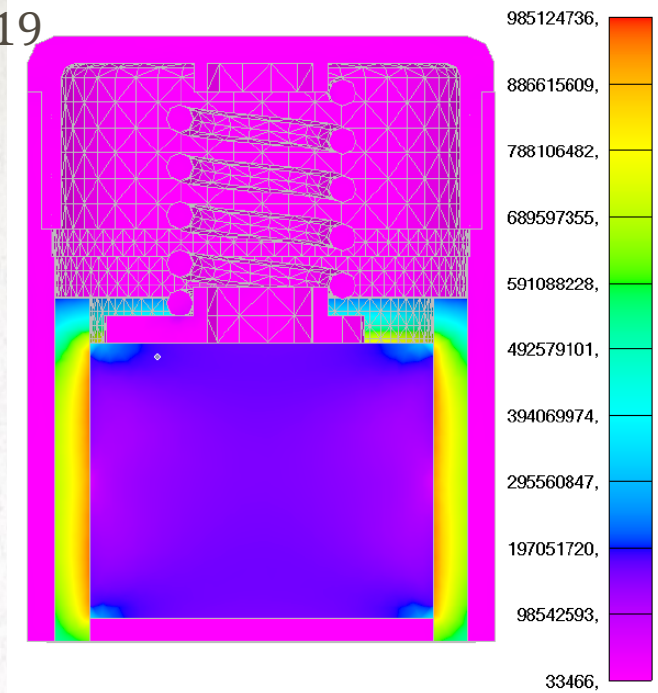

Slika 4.28 Raspodjela naprezanja pri 310°C.

Marko Bertetić, 2020